

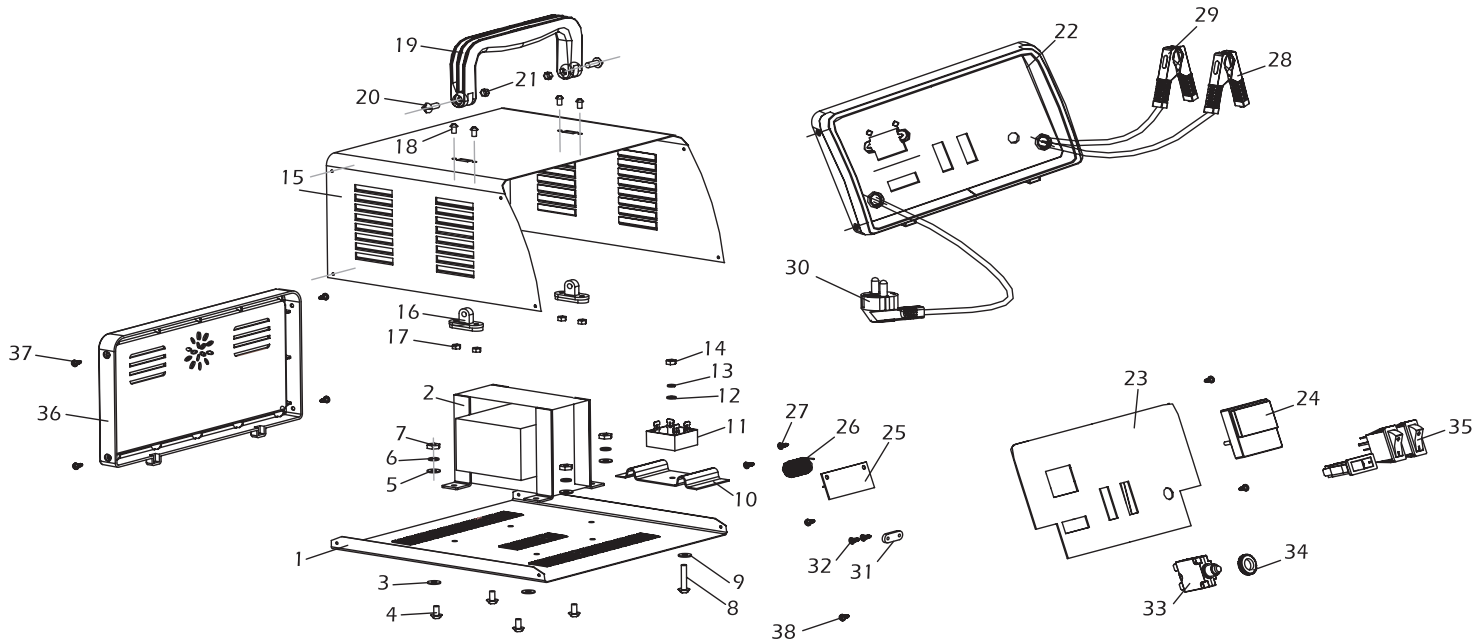

SPARE PARTS LISTING & DRAWING SHEET FOR 6/12V 8.4A Battery Charger

Stock No.20492

Part No.BCD9



KEY No.	PART No.	STOCK No.	DESCRIPTION
1	YHBCM1206S-1	22618	Bottom
2	YHBCM1212S-2	22655	Transformer
3	YHBCM1206S-3	22619	4 Washer
4	YHBCM1206S-4	22620	4X8 Screw
5	YHBCM1206S-3	22619	4 Washer
6	YHBCM1206S-6	22621	4 Spring washer
7	YHBCM1206S-7	22622	4 Screw cap
8	YHBCM1206S-8	22623	4X20 Screw
9	YHBCM1206S-3	22619	4 Washer
10	YHBCM1206S-10	22624	Radiator
11	YHBCM1212S-11	22656	Rectifier
12	YHBCM1206S-6	22621	4 Spring washer
13	YHBCM1206S-3	22619	4 Washer
14	YHBCM1206S-7	22622	M4 Screw cap
15	YHBCM1206S-15	22625	Main body
16	YHBCM1206S-16	22626	Portable stator
17	YHBCM1206S-7	22622	M4 Nut
18	YHBCM1206S-4	22620	4X8 Screw
19	YHBCM1206S-19	22628	Handle

KEY No.	PART No.	STOCK No.	DESCRIPTION
20	YHBCM1206S-20	22629	4X4 Screw
21	YHBCM1206S-7	22622	M4 Nut
22	YHBCM1206S-22	22630	Front plate
23	YHBCM1212S-23	22657	Label
24	YHBCM1206S-24	22635	Amperemeter
25	YHBCM1206S-25	22636	PCB
26	YHBCM1206S-26	22637	Resistor
27	YHBCM1206S-27	22638	3X8 Screw
28	YHBCM1206S-28	22639	Red positive clamp
29	YHBCM1206S-29	22640	Black negative clamp
30	YHBCM1206S-30	22641	Electrical outlet
31	YHBCM1206S-31	22642	Hold-down plate
32	YHBCM1206S-32	22643	3X10 Screw
33	YHBCM1206S-33	22644	Overloading protection
34	YHBCM1206S-34	22646	Protect nut
35	YHBCM1206S-35	22647	Switch
36	YHBCM1206S-36	22648	Rear plate
37	YHBCM1206S-37	22638	3X8 Screw
38	YHBCM1206S-38	22638	3X8 Screw

Helpline: (023) 8049 4344. Sales Desk: (023) 8049 4333. General Enquiries: (023) 8026 6355.

DRAPER TOOLS LTD, HURSLEY ROAD, CHANDLER'S FORD, EASTLEIGH, HANTS. SO53 1YF. U.K. internet: www.draper.co.uk e-mail: sales@drapertools.com