

DRAPER[®]

INSTRUCTIONS FOR Micrometer Adjustment Torque Wrenches

Stock No. **34570**
30357
34964

Part No. **3004A**
3001A
3005A

IMPORTANT: PLEASE READ THESE INSTRUCTIONS CAREFULLY TO ENSURE THE SAFE AND EFFECTIVE USE OF THIS PRODUCT.



DRAPER[®]

GENERAL INFORMATION

These instructions accompanying the product are the original instructions. This document is part of the product, keep it for the life of the product passing it on to any subsequent holder of the product. Read all these instructions before assembling, operating or maintaining this product.

This manual has been compiled by Draper Tools describing the purpose for which the product has been designed, and contains all the necessary information to ensure its correct and safe use. By following all the general safety instructions contained in this manual, it will ensure both product and operator safety, together with longer life of the product itself.

All photographs and drawings in this manual are supplied by Draper Tools to help illustrate the operation of the product. Whilst every effort has been made to ensure the accuracy of information contained in this manual, the Draper Tools policy of continuous improvement determines the right to make modifications without prior warning.

Contents/Guarantee	1
Specification	2
Safety instructions	3
Getting to know your torque wrench	4
Operation and use	5-8
Conversion chart	9

Draper tools have been carefully tested and inspected before shipment and are guaranteed to be free from defective materials and workmanship.

Should the tool develop a fault, please return the complete tool to your nearest distributor or contact Draper Tools Limited, Chandler's Ford, Eastleigh, Hampshire, SO53 1YF, England.
Telephone Sales Desk: (023) 8049 4333 or Product Helpline (023) 8049 4344.

A proof of purchase must be provided with the tool.

If upon inspection it is found that a fault occurring is due to defective materials or workmanship, repairs will be carried out free of charge. The guarantee period covering parts/labour is 12 months from the date of purchase. This guarantee does not apply to normal wear and tear, nor does it cover any damage caused by misuse, careless or unsafe handling, alterations, accidents, or repairs attempted or made by any personnel other than the authorised Draper warranty repair agents.

Note: If the tool is found not to be within the Terms of Warranty, repair and carriage charges will be quoted and made accordingly.

This guarantee applies in lieu of any other guarantee expressed or implied and variations of its terms are not authorised.

Your Draper guarantee is not effective unless you can produce upon request a dated receipt or invoice to verify your proof of purchase within the guarantee period.

Please note that this guarantee is an additional benefit and does not affect your statutory rights.

Draper Tools Limited.

Note: This tool is intended for domestic use only.



SPECIFICATION

The Draper Tools policy of continuous improvement determines the right to change specification without notice.

Stock no.	34570	30357	34964
Part no.	3004A	3001A	3005A
Square drive size	$\frac{3}{8}$ "	$\frac{1}{2}$ "	$\frac{3}{4}$ "
Marked range	10-80Nm/ 88.5-708lb-in	30-210Nm/ 22.1-154.9lb-ft	70-395Nm/ 51.6-291lb-ft
Overall length	280mm	475mm	670mm

Whilst every effort has been made to ensure that the accuracy of information given in this manual is correct at time of going to print, the Draper Tools policy of continuous improvement determines the right to change specification without notice.

⚠ WARNING! Never use the torque wrench to undo bolts, nuts or fasteners, as this will damage the ratchet and the calibrated setting

If the torque fails to function correctly for any of the following reasons, return the torque wrench to your local Draper Tools stockist. A repair service is available.

1. Ratchet fails to function.
2. Handle lock fails to function.
3. Handle lock nut comes loose.
4. No audible click.
5. Handle does not break at set torque.
6. Out of calibration.
7. Always refer to manufacturer's literature, workshop manual or Haynes manual for recommended TORQUE SETTINGS and if applicable the sequence for tightening and final torquing of fasteners.

IMPORTANT: The torque wrenches detailed in this instruction leaflet are for right hand torquing only. They are not designed for left hand thread use.

- This torque wrench is designed for general purpose use.
- If critical torque measurement is required, it is recommended the torque wrench is independently calibrated before first use and that the user puts in place a re-calibration schedule appropriate for the application.
- Draper Tools offer a full range of precision torque wrenches for this type of application, contact your stockist for further details.

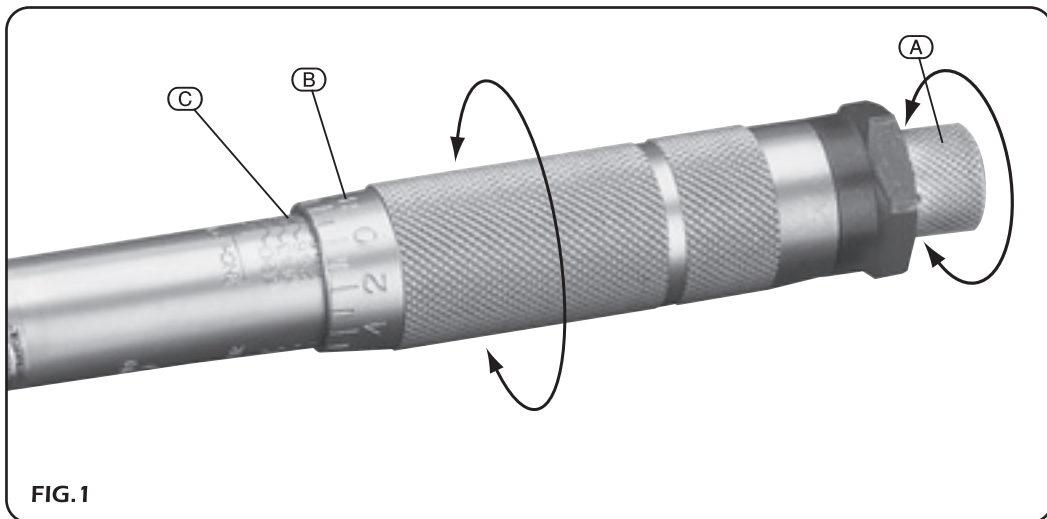

FIG. 1

- **NOTE:** Always set by turning the handle in the clockwise direction.
 1. To unlock handle, turn locking screw anti-clockwise (A).
 2. Turn handle clockwise until the correct whole number of the setting is reached (B).
 3. Continue to turn the handle for any additional increments to obtain the final setting (C).
 4. Lock handle, turn locking screw clockwise (A).
 5. When the torque wrench is not in use, ensure adjustment at the lowest torque setting.

- IMPORTANT:

Always use the correct size socket and if necessary, accessory.

Apply a steady pull to the handle of the torque wrench. When the applied torque is reached, this will be indicated by the following:

1. Audible click:

NOTE: The click will be quieter at lower torque settings.

2. Touch:

The handle will be felt to "break away" at the point of the set torque.

3. Visually:

The handle will be seen to "break away" at the point of the set torque.

- WARNING:

- Never continue to pull on the torque wrench once the set torque is reached, as this will result in an incorrect torque being applied and possible damage to parts.
- If the torque wrench has not been used i.e. new or has been in storage for some time, operate it several times at a low torque setting, which allows the internal lubrication to recoat working parts.
- When the torque wrench is not in use, ensure adjustment at the lowest torque setting.
- Do not turn adjustment below lowest torque setting.
- Never use the torque wrench to undo nuts, bolts or fasteners. This will result in the ratchet mechanism being damaged.
- The tool is rugged and designed for workshop use, but it is also a precision measuring instrument and should be treated as such.
- Clean wrench by wiping. Do not immerse in any type of cleaner which will affect the internal lubrication.
- Under no circumstances should any attempt be made to adjust or repair the torque wrench. A full repair and calibration service is available on request. A charge will be made accordingly.
- It is recommended that a re-calibration schedule is put in place by the user to ensure the torque wrench is performing within its design criteria.

- **SETTING EXAMPLE $\frac{3}{8}$ " SQUARE DRIVE (Figs.2-5):**

Stock No.34570 Part No.3004A

- Torque wrench set to 36Nm.
 1. Unlock handle (Fig.1) (Page 4).
 2. 30Nm. whole number (Fig.2).
 3. 1 div. on handle = 1Nm.
6 div. = 6Nm.
30 + 6 = 36Nm. (Fig.3).
 4. Lock handle (Fig.1) (Page 4).

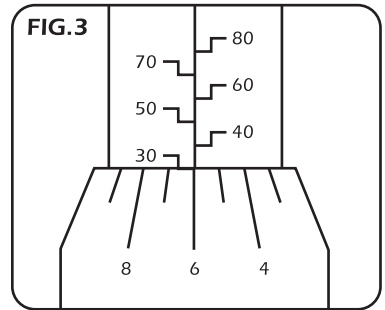
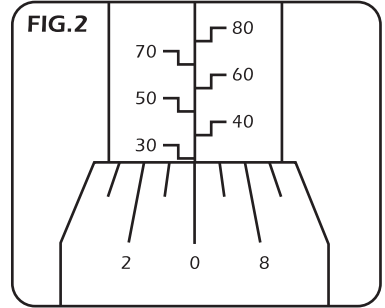

- Torque wrench set to 318.8 in-lb.
 1. Unlock handle. (Fig.1) (Page 4).
 2. 266 in-lb. whole number (Fig.4).
 3. 1 div. on handle = 8.8 in-lb.
6 div. = 52.8 in-lb.
266 + 52.8 = 318.8 in-lb. (Fig.5).
 4. Lock handle. (Fig.1) (Page 4).

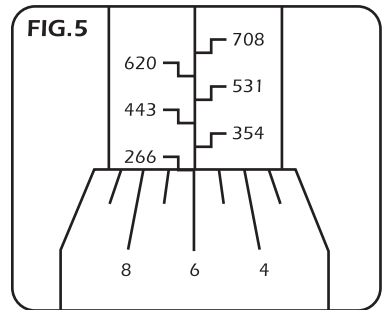
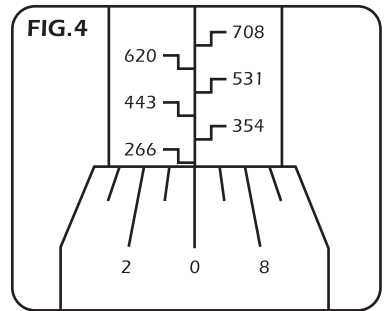

- **SETTING EXAMPLE 1/2" SQUARE DRIVE (Figs.6-9):**

Stock No.30357 Part No.3001A

- Torque wrench set to 96Nm.
 1. Unlock handle (Fig.1) (Page 4).
 2. 90Nm. whole number (Fig.6).
 3. 1 div. on handle = 1Nm.
6 div. = 6Nm.
90 + 6 = 96Nm (Fig.7).
 4. Lock handle (Fig.1) (Page 4).

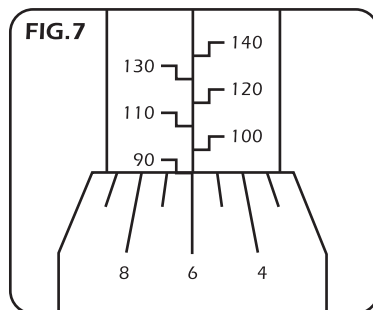
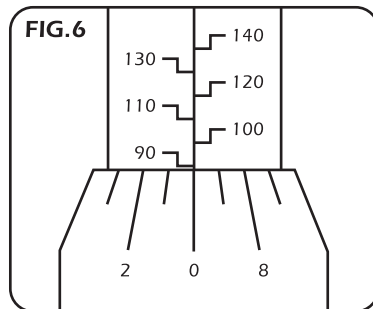

- Torque wrench set to 70.84 ft-lb.
 1. Unlock handle (Fig.1) (Page 4).
 2. 66.4 ft-lb. whole number (Fig.8).
 3. 1 div. on handle = 0.74 ft-lb.
6 div. = 4.44 ft-lb.
66.4 + 4.44 = 70.84 ft-lb (Fig.9).
 4. Lock handle (Fig.1) (Page 4).

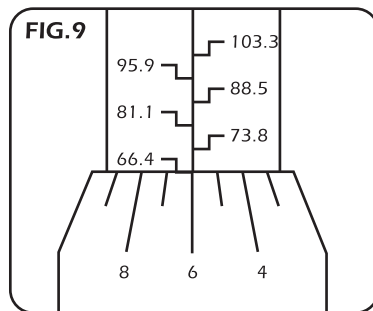
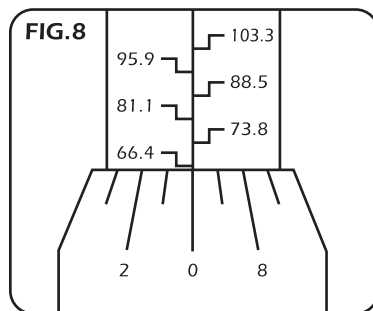

- **SETTING EXAMPLE $\frac{3}{4}$ " SQUARE DRIVE (Figs.10-13):**

Stock No.34964 Part No.3005A

- Torque wrench set to 180Nm.
 1. Unlock handle (Fig.1) (Page 4).
 2. 170Nm. whole number (Fig.10).
 3. 1 div. on handle = 1Nm.
10 div. = 10Nm.
170 + 10 = 180Nm (Fig.11).
 4. Lock handle (Fig.1) (Page 4).

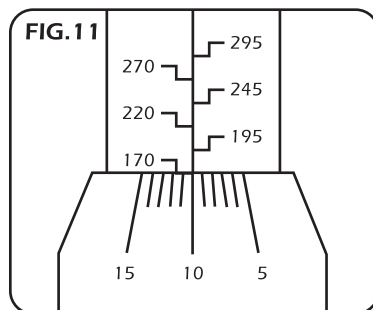
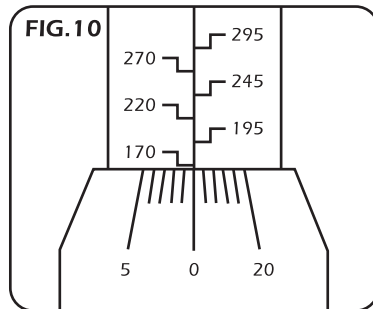

- Torque wrench set to 132.8 ft.lb.
 1. Unlock handle (Fig.1) (Page 4).
 2. 125.4 ft.lb. whole number (Fig.12).
 3. 1 div. on handle = 0.74 ft.lb.
10 div. = 7.4 ft.lb.
125.4 + 7.4 = 132.8 ft.lb (Fig.13).
 4. Lock handle (Fig.1) (Page 4).

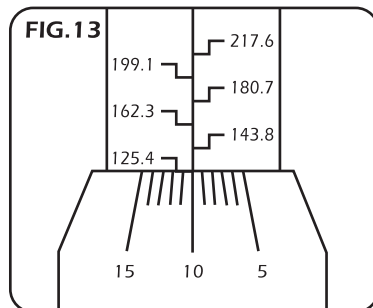
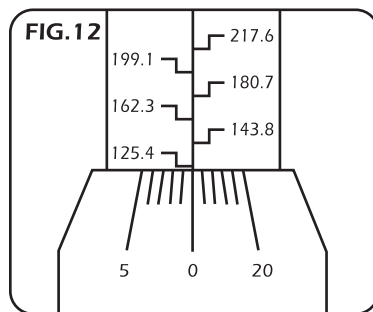



CONVERSION CHART

	mN/m <small>millinewton-metre</small>	cN/m <small>centinewton-metre</small>	N/m <small>newton-metre</small>	daN/m <small>decanewton-metre</small>	cm/kg <small>centimetre-kg</small>	m/kg <small>metre-kg</small>	in-oz <small>inch-ounce</small>	in-lb <small>inch-pound</small>	ft-lb <small>foot-pound</small>
1mN/m	1	0.1	0.001	0.0001	0.0102	0.000102	0.1416	0.00885	0.000738
1cN/m	10	1	0.01	0.001	0.102	0.00102	1.416	0.0885	0.00738
1N/m	1000	100	1	0.1	10.2	0.102	141.6	8.85	0.738
1daN/m	10000	1000	10	1	102	1.02	1416	88.5	7.38
1cm/kg	98	9.8	0.098	0.0098	1	0.01	13.9	0.868	0.0723
1m/kg	9810	981	9.81	0.98	100	1	1390	86.8	7.23
lin-oz	7.06	0.706	0.00706	0.0007	0.072	0.00072	1	16	192
lin-lb	112.9	11.29	0.1129	0.01129	1.152	0.0115	0.063	1	12
lft-lb	1355	35	1.355	0.1135	13.8	0.138	0.0052	0.083	1

- **DRAPER TOOLS LIMITED,**
Hursley Road, Chandler's Ford,
Eastleigh, Hampshire. SO53 1YF. U.K.
- **Helpline:** (023) 8049 4344
- **Sales Desk:** (023) 8049 4333
- **Internet:** www.draper.co.uk
- **E-mail:** sales@drapertools.com
- **Sales Fax:** (023) 8049 4209
- **General Enquiries:** (023) 8026 6355
- **Service/Warranty Repair Agent**
For aftersales servicing or warranty repairs, please contact the Draper Tools Helpline for details of an agent in your local area.

YOUR DRAPER STOCKIST

PJL180612

©Published by Draper Tools Limited.

No part of this publication may be reproduced, stored in a retrieval system or transmitted in any form or by any means, electronic, mechanical photocopying, recording or otherwise without prior permission in writing from Draper Tools Ltd.