



THE TOOL COMPANY

SINGLE FLUORESCENT CORNER LAMP FITTING

■ STOCK No. 63260
63261

■ PART No. LFC-20
LFC-40

• INSTRUCTIONS •

IMPORTANT: PLEASE READ THESE INSTRUCTIONS CAREFULLY TO ENSURE THE SAFE AND EFFECTIVE USE OF THIS TOOL.

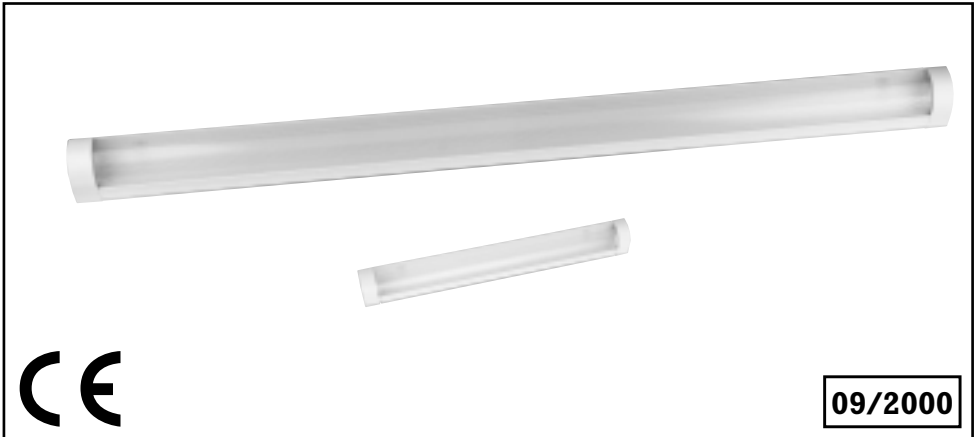

GENERAL INFORMATION

This manual has been compiled by Draper Tools, which should be kept in a safe place.

This manual describes the purpose for which this lamp frame has been designed and contains all the necessary information to ensure its correct and safe use. We recommend that this manual is read before any operation of the lamp, before performing any kind of adjustment to the lamp, and prior to any maintenance tasks. By following all the general safety instructions contained in this manual, it will ensure both lamp and operator safety, together with longer life of the lamp itself.

All photographs and drawings in this manual are supplied by Draper Tools to help illustrate the operation of the lamp frame.

Whilst every effort has been made to ensure accuracy of information contained in this manual, the Draper Tool policy of continuous improvement determines the right to make modifications without prior warning.



THE TOOL COMPANY

SINGLE FLUORESCENT CORNER LAMP FITTING

■ STOCK No. 63260
63261

■ PART No. LFC-20
LFC-40

SPECIFICATIONS:

1. Rated voltage: AC 100-240V~50Hz.
2. $\lambda=0.90C$, $\mu=0.95$, $T_c=50^\circ C$.
3. Products of LFC series are assembled with G13 lamp holder and T8 lighting tube (not supplied). They are easy to carry and install, and can be connected together to a maximum of 8 fittings.

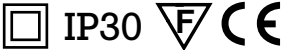

t_a 25°C



THE TOOL COMPANY

DECLARATION OF CONFORMITY

We

Draper Tools Ltd. Hursley Road, Chandler's Ford, Eastleigh, Hampshire.
SO53 1YF. England.

Declare under our sole responsibility that the product:

Stock Nos:- 63260 & 63261.

Part Nos:- LFC-20 & LFC-40.

Description:- Fluorescent Lamp Frame.

To which this declaration relates is in conformity with the following directive(s)
73/23/EEC & 89/336/EEC.

With reference to: EN60598-1, EN50081-1, EN55022, EN61000-3-2/-3, EN50082-1,
EN61547, (EN61000-4-2/-3/-4/-5/-6/-11).

JOHN DRAPER
Managing Director

Issue Date: 28/07/2000

INSTALLATION

1. Remove right-hand end cover and lampshade.
2. Mark fixing holes in desired location on mounting surface.
3. Feed mains supply wire through either hole on end covers and connect to the relevant contact points in the terminal block located on the right-hand end of the lamp frame.
4. Once all wiring connections are complete, mount the lamp frame in the position required, then carefully install the fluorescent tube (not supplied) and replace the lampshade and end cover(s).
5. If in doubt consult a qualified electrician for advice or installation.

STOCK No.63260

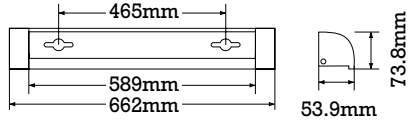

STOCK No.63261

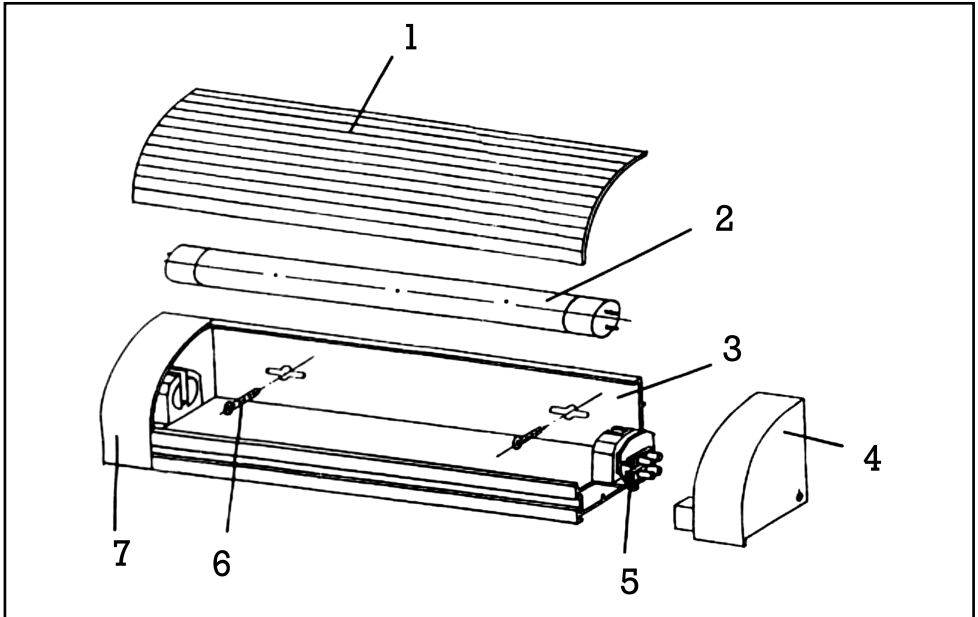
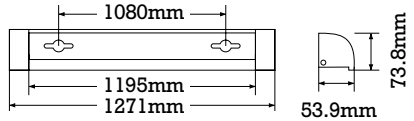

1. Lampshade
2. Fluorescent tube (not supplied)
3. Frame
4. Right end cover
5. Terminal block
6. Screw
7. Left end cover

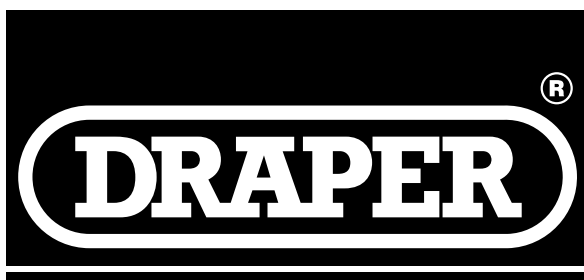

THE TOOL COMPANY

DRAPER TOOLS LIMITED,

Hursley Road, Chandler's Ford, Eastleigh, Hants. SO53 1YF. U.K.

Helpline: (023) 8049 4344.

Sales Desk: (023) 8049 4333.

General Enquiries: (023) 8026 6355.

Fax: (023) 8026 0784.



www.draper.co.uk

e-mail: sales@draper.co.uk

YOUR DRAPER STOCKIST

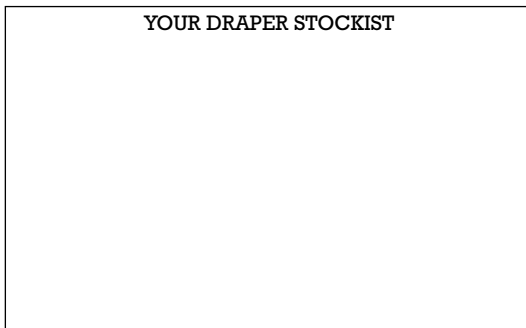

©Published by Draper Tools Ltd.

No part of this publication may be reproduced, stored in a retrieval system or transmitted in any form or by any means, electronic, mechanical photocopying, recording or otherwise without prior permission in writing from Draper Tools Ltd.