

**DRAPER**<sup>®</sup>

230V 2200W

# PRESSURE WASHER

83414



**IMPORTANT:** Please read these instructions carefully to ensure the safe and effective use of this product and save these instructions for future reference. This manual has been compiled by Draper Tools and is an integrated part of the product with which it is enclosed and should be kept with it for future references.

This manual describes the purpose for which the product has been designed and contains all the necessary information to ensure its correct and safe use. We recommend that this manual is read before any operation or, before performing any kind of adjustment to the product and prior to any maintenance tasks. By following all the general safety instructions contained in this manual, it will ensure both product and operator safety, together with longer life of the product itself.

All photographs and drawings in this manual are supplied by Draper Tools to help illustrate the operation of the product. Whilst every effort has been made to ensure accuracy of information contained in this manual, the Draper Tools policy of continuous improvement determines the right to make modifications without prior warning.

# 1. TITLE PAGE

---

## 1.1 INTRODUCTION:

**USER MANUAL FOR: 230V PRESSURE WASHER**

**Stock No: 83414**

**Part No: PW2200**

## 1.2 REVISIONS:

**Date first published March 2018.**

---

---

---

---

---

As our user manuals are continually updated, users should make sure that they use the very latest version.

**Downloads are available from:** <http://drapertools.com/manuals>

Draper Tools Limited  
Hursley Road  
Chandler's Ford  
Eastleigh  
Hampshire  
SO53 1YF  
UK

**Website:** [drapertools.com](http://drapertools.com)

**Product Helpline:** +44 (0) 23 8049 4344

**General Fax:** +44 (0) 23 8026 0784

## 1.3 UNDERSTANDING THIS MANUALS SAFETY CONTENT:

**WARNING!** – Information that draws attention to the risk of injury or death.

**CAUTION!** – Information that draws attention to the risk of damage to the product or surroundings.

## 1.4 COPYRIGHT © NOTICE:

Copyright © Draper Tools Limited.

Permission is granted to reproduce this publication for personal and educational use only. Commercial copying, redistribution, hiring or lending is prohibited.

No part of this publication may be stored in a retrieval system or transmitted in any other form or means without written permission from Draper Tools Limited.

In all cases this copyright notice must remain intact.

# 2. CONTENTS

---

## 2.1 CONTENTS

<b>Page content</b> .....	<b>Page</b>
1 TITLE PAGE	
1.1 INTRODUCTION .....	2
1.2 REVISION HISTORY .....	2
1.3 UNDERSTANDING THIS MANUAL .....	2
1.4 COPYRIGHT NOTICE .....	2
2 CONTENTS	
2.1 CONTENTS .....	3
3 GUARANTEE	
3.1 GUARANTEE .....	4
4 INTRODUCTION	
4.1 SCOPE .....	5
4.2 SPECIFICATION .....	5
4.3 HANDLING & STORAGE .....	5
5 HEALTH & SAFETY INFORMATION	
5.1 GENERAL SAFETY INSTRUCTIONS FOR POWER TOOL USE .....	6-7
5.2 SPECIFIC SAFETY INSTRUCTIONS FOR PRESSURE WASHER USE .....	8-9
5.3 CONNECTION TO THE POWER SUPPLY .....	9
6 IDENTIFICATION	
6.1 IDENTIFICATION .....	10
6.2 TOTAL STOP DEVICE .....	11
7 UNPACKING & CHECKING	
7.1 PACKAGING .....	12
7.2 WHAT'S IN THE BOX? .....	12
8 SETTING THE PRESSURE WASHER	
8.1 FITTING THE LANCE HOLDER .....	13
8.2 ASSEMBLING THE CABLE TIDY .....	13
8.3 ASSEMBLING THE LANCE AND HOSE .....	14
8.4 ATTACHING THE WATER SUPPLY .....	15
9 OPERATION AND USE	
9.1 ON/OFF SWITCH .....	16
10 ACCESSORIES	
10.1 90° NOZZLE .....	17
10.2 FIXED BRUSH .....	17
10.3 TURBO NOZZLE .....	17
10.4 ASSEMBLING AND ATTACHING THE PATIO CLEANER .....	18
11 TROUBLESHOOTING	
11.1 TROUBLE SHOOTING .....	19
11.2 CLEANING PIN .....	19
12 EXPLANATION OF SYMBOLS	
12.1 EXPLANATION OF SYMBOLS .....	20
13 DISPOSAL	
13.1 DISPOSAL .....	21
DECLARATION OF CONFORMITY .....	ENCLOSED

# 3. GUARANTEE

---

## 3.1 GUARANTEE

Draper tools have been carefully tested and inspected before shipment and are guaranteed to be free from defective materials and workmanship.

Should the tool develop a fault, please return the complete tool to your nearest distributor or contact:

**Draper Tools Limited, Chandler's Ford, Eastleigh, Hampshire, SO53 1YF. England.**

**Telephone Sales Desk: (023) 8049 4333 or:**

**Product Helpline (023) 8049 4344.**

A proof of purchase must be provided.

If upon inspection it is found that the fault occurring is due to defective materials or workmanship, repairs will be carried out free of charge. This guarantee period covering parts/labour is 12 months from the date of purchase except where tools are hired out when the guarantee period is 90 days from the date of purchase. The guarantee is extended to 24 months for parts only. This guarantee does not apply to normal wear and tear, nor does it cover any damage caused by misuse, careless or unsafe handling, alterations, accidents, or repairs attempted or made by any personnel other than the authorised Draper warranty repair agent.

Note: If the tool is found not to be within the terms of warranty, repairs and carriage charges will be quoted and made accordingly.

This guarantee applies in lieu of any other guarantee expressed or implied and variations of its terms are not authorised.

Your Draper guarantee is not effective unless you can produce upon request a dated receipt or invoice to verify your proof of purchase within the guarantee period.

Please note that this guarantee is an additional benefit and does not affect your statutory rights.

**Draper Tools Limited.**

# 4. INTRODUCTION

---

## 4.1 SCOPE

This machine is designed to clean machinery and property around the work place and home. It delivers a high pressure jet that can cope in heavy duty cleaning applications

## 4.2 SPECIFICATION

Stock no .....	83414
Part no .....	PW2200
Rated voltage .....	230V~50Hz
Rated input .....	2200W
Working pressure .....	1595psi (110Bar)
Max. permissible pressure .....	2393psi (165Bar)
Max. flow rate .....	5.5L/min (330L/hour)
Type of protection .....	IPX5
Max. water feed temperature .....	40°C
Guaranteed sound power level .....	100dB(A)
Weight (nett) .....	10.5kg

## 4.3 HANDLING & STORAGE

This pressure washer and accompanying accessories should not be stored at or below 0°C. Frozen water inside the machine can cause critical damage to pump and other components.

## 5. HEALTH & SAFETY INFORMATION

---

Have this tool repaired by a qualified person. This tool is designed to conform to the relevant international and local standards and as such should be maintained and repaired by someone qualified; using only original parts supplied by the manufacturer: This will ensure the tool remains safe to use.

### 5.1 GENERAL SAFETY INSTRUCTIONS FOR POWER TOOL USE

**Warning:** Read all safety warnings and all instructions. Failure to follow the warnings and instructions may result in electric shock, fire and/or serious injury.

**Save all warnings and instructions for future reference.**

The term “power tool” in the warnings refers to your mains operated (corded) power tool or battery-operated (cordless) power tool.

#### 1) Work area safety

- a) **Keep work area clean and well lit.** Cluttered or dark areas invite accidents.
- b) **Do not operate power tools in explosive atmospheres, such as in the presence of flammable liquids, gases or dust.** Power tools create sparks which may ignite the dust or fumes.
- c) **Keep children and bystanders away while operating a power tool.** Distractions can cause you to lose control.

#### 2) Electrical safety

- a) **Power tool plugs must match the outlet. Never modify the plug in any way. Do not use any adapter plugs with earthed (grounded) power tools.** Unmodified plugs and matching outlets will reduce risk of electric shock.
- b) **Avoid body contact with earthed or grounded surfaces such as pipes, radiators, ranges and refrigerators.** There is an increased risk of electric shock if your body is earthed or grounded.
- c) **Do not expose power tools to rain or wet conditions.** Water entering a power tool will increase the risk of electric shock.
- d) **Do not abuse the cord. Never use the cord for carrying, pulling or unplugging the power tool. Keep cord away from heat, oil, sharp edges or moving parts.** Damaged or entangled cords increase the risk of electric shock.
- e) **When operating a power tool outdoors, use an extension cord suitable for outdoor use.** Use of a cord suitable for outdoor use reduces the risk of electric shock.
- f) **If operating a power tool in a damp location is unavoidable, use a residual current device (RCD) protected supply.** Use of an RCD reduces the risk of electric shock.

#### 3) Personal safety

- a) **Stay alert, watch what you are doing and use common sense when operating a power tool. Do not use a power tool while you are tired or under the influence of drugs, alcohol or medication.** A moment of inattention while operating power tools may result in serious personal injury.
- b) **Use personal protective equipment. Always wear eye protection.** Protective equipment such as dust mask, non-skid safety shoes, hard hat, or hearing protection used for appropriate conditions will reduce personal injuries.
- c) **Prevent unintentional starting. Ensure the switch is in the off position before connecting to power source and/or battery pack, picking up or carrying the tool.** Carrying power tools with your finger on the switch or energising power tools that have the switch on invites accidents.
- d) **Remove any adjusting key or wrench before turning the power tool on.** A wrench or a key left attached to a rotating part of the power tool may result in personal injury.
- e) **Do not overreach. Keep proper footing and balance at all times.** This enables better control of the power tool in unexpected situations.

## 5. HEALTH & SAFETY INFORMATION

---

- f) **Dress properly. Do not wear loose clothing or jewellery. Keep your hair, clothing and gloves away from moving parts.** Loose clothes, jewellery or long hair can be caught in moving parts.
  - g) **If devices are provided for the connection of dust extraction and collection facilities, ensure these are connected and properly used.** Use of these devices can reduce dust-related hazards.
- 4) **Power tool use and care**
- a) **Do not force the power tool. Use the correct power tool for your application.** The correct power tool will do the job better and safer at the rate for which it was designed.
  - b) **Do not use the power tool if the switch does not turn it on and off.** Any power tool that cannot be controlled with the switch is dangerous and must be repaired.
  - c) **Disconnect the plug from the power source and/or battery pack from the power tool before making any adjustments, changing accessories, or storing power tools.** Such preventive safety measures reduce the risk of starting the power tool accidentally.
  - d) **Store idle power tools out of the reach of children and do not allow persons unfamiliar with the power tool or these instructions to operate the power tool.** Power tools are dangerous in the hands of untrained users.
  - e) **Maintain power tools. Check for misalignment or binding of moving parts, breakage of parts and any other condition that may affect the power tool's operation. If damaged, have the power tool repaired before use.** Many accidents are caused by poorly maintained power tools.
  - f) **Keep cutting tools sharp and clean.** Properly maintained cutting tools with sharp cutting edges are less likely to bind and are easier to control.
  - g) **Use the power tool, accessories and tool bits etc. in accordance with these instructions, taking into account the working conditions and the work to be performed.** Use of the power tool for operations different from those intended could result in a hazardous situation.
- 5) **Service**
- a) **Have your power tool serviced by a qualified repair person using only identical replacement parts.** This will ensure that the safety of the power tool is maintained.











### IMPORTANT

**If using an extension lead, follow the instructions that came with your lead regarding maximum load while cable is wound. If in doubt, ensure that the entire cable is unwound. Using a coded extension lead will generate heat which could melt the lead and cause a fire.**

## 5. HEALTH & SAFETY INFORMATION

---







### 5.2 SPECIFIC SAFETY INSTRUCTIONS FOR PRESSURE WASHER USE

-  Warning: This appliance is for outdoor use only.
-  Warning: Always disconnect the electricity and water supplies on completion of every job.
-  Warning: Never use the appliance if the electrical cable or important parts of the appliance are damaged, e.g. safety devices, high pressure hose, gun, etc.
-  Warning: This appliance has been designed for use with a neutral shampoo based on biodegradable anionic surface active detergents. The use of other detergents or chemicals may put the appliance's safety at risk.
-  Warning: Never use the appliance with people in the vicinity, unless they are wearing protective clothing.
-  Warning: Do not direct the nozzle toward mechanical parts containing lubricant grease, as the grease will dissolve and spread over the surrounding ground. Vehicle tyres/tyre valves may only be cleaned from a minimum distance of 30cm, otherwise the vehicle tyre/tyre valve could be damaged by the high-pressure jet. The first indication of this is a discolouration of the tyre. Damaged vehicle tyres/tyre valves can be deadly dangerous.
-  Warning: High pressure jets may be dangerous if improperly used. Jets must never be pointed at people, animals, live electrical equipment or the appliance itself.
-  Warning: The hoses, accessories and high pressure couplings are important for the appliance's safety. Use only hoses, accessories and couplings recommended (it is extremely important to protect these components against damage by avoiding their improper use and protecting them against bending, knocks and scratches).
- The gun is fitted with a safety catch. Whenever use of the machine is interrupted it is important to operate the safety catch to prevent accidental activation of the jet.
-  Warning:
- Never point the jet at yourself or others to clean clothing or footwear.
  - Never allow children or untrained people to use the appliance.
  - Safety features: gun equipped with safety locking device, appliance
  - equipped with (Class 1) overload cutout, pump equipped with by-pass
  - valve or shutdown device.
  - The safety button on the gun is not there to lock the lever during operation, but to prevent its accidental operation.
-  Warning: Appliances equipped with Total Stop System: these appliances should not be left in standby for more than 5 minutes.
-  Warning: Switch the appliance off completely (master switch ON/OFF) whenever it is left unattended.



## 5. HEALTH & SAFETY INFORMATION

---

-  Warning: Every machine is tested in its operating conditions, so it is normal for a few drops of water to be left inside it.
-  Warning: Take care not to damage the electric cable. Have a damaged power cord replaced immediately by an authorized service point or an electrical specialist.
-  Warning: The high pressure hose is designed and produced to withstand high pressures. To avoid damage, it must be handled with special care. Misuse may lead to premature breakages or damage and cause the loss of warranty cover.
-  Warning: Never start the high-pressure cleaner without first completely unwinding the high-pressure hose.
-  Warning: When winding and unwinding the hose take care not to cause the high pressure cleaner to overturn.
-  Warning: Before unwinding or winding the hose, switch the machine off and release the pressure in the hose itself (switching off).

### 5.3 CONNECTION TO THE POWER SUPPLY

**Caution:** Risk of electric shock. Do not open.

This appliance is supplied with a moulded 3 pin mains plug for your safety. The value of the fuse fitted is marked on the pin face of the plug. Should the fuse need replacing, ensure the substitute is of the correct rating, approved to BS1362 and ASTA or BS Kite marked.

ASTA 

BSI 

The fuse cover is removable with a small plain slot screwdriver. Ensure the fuse cover is replaced before attempting to connect the plug to an electrical outlet. If the cover is missing, a replacement must be obtained or the plug replaced with a suitable type.

If a replacement plug is to be fitted this must be carried out by a qualified electrician.

The damaged or incomplete plug, when cut from the cable should be disabled to prevent connection to a live electrical outlet.

This appliance is Class II† and is designed for connection to a power supply matching that detailed on the rating label and compatible with the plug fitted.

If an extension lead is required, use an approved and compatible lead rated for this appliance. Follow all the instruction supplied with the extension lead.

†Double insulated : This product requires no earth connection as supplementary insulation is applied to the basic insulation to protect against electric shock in the event of failure of the basic insulation.

**Important: If using an extension lead, follow the instructions that came with your lead regarding maximum load while cable is wound. If in doubt, ensure that the entire cable is unwound. Using a coded extension lead will generate heat which could melt the lead and cause a fire.**

# 6. TECHNICAL DESCRIPTION

## 6.1 IDENTIFICATION



- ① Hose cart wheel handle
- ② Hose reel
- ③ 5M High pressure hose
- ④ Transport handle
- ⑤ Integrated detergent bottle
- ⑥ Moulded approved plug and cable

- ⑦ ON/OFF Switch
- ⑧ Wheel
- ⑨ Water inlet
- ⑩ Water outlet
- ⑫ Detergent filler cap
- ⑬ Spare nozzle accessory storage

## 6. TECHNICAL DESCRIPTION

---

### 6.2 TOTAL STOP DEVICE



This pressure washer is fitted with the TOTAL STOP DEVICE. This will cause the motor to start and stop when the trigger is activated, unlike standard washers where the motor would run continuously.

This device reduces the amount of water and electricity used and the amount of wear and tear on the machines components. Also this helps cut down on the amount of noise emitted during use.

# 7. UNPACKING & CHECKING

## 7.1 PACKAGING

Carefully remove the product from the packaging and examine it for any sign of damage caused during shipping. Lay the contents out and check them. If any part is damaged or missing, do not attempt to use the tool and contact the Draper Helpline immediately (see back page for details). Retain the packaging material at least during the guarantee period: in case the machine needs to be returned for repair.

**Warning!** Some of the packaging materials used may be harmful to children, keep them out of reach from children.

Disposed of any packaging correctly and according to local regulations.

## 7.2 WHAT'S IN THE BOX?

As well as the pressure washer unit there are several attaching parts.



(11) Patio cleaning brush.

(12) Cable tidy.

(13) Trigger.

(14) Hose reel handle.

(15) Side lance mounting bracket.

(16) Trigger lock.

(17) Trigger assembly.

(18) Water inlet connection fitting.

(19) Lance.

(20) Patio cleaning spray.

(21) Patio cleaning lance.

(22) Cleaning pin.

(23) Adjustable jet nozzle.

(24) 90° nozzle.

(25) Turbo nozzle.

(26) Fixed brush.

(27) Patio cleaner screws and split pin.

## 8. SETTING THE PRESSURE WASHER

### NOTE:

Remove the plug from the socket before carrying out adjustment, servicing or maintenance.

### 8.1 FITTING THE LANCE HOLDER - FIG. 1

Attach the side lance holder (15), locate and slide.

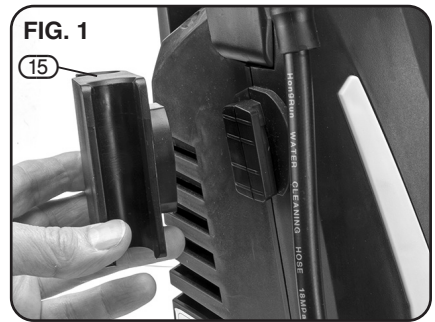

### 8.2 ASSEMBLING THE CABLE TIDY & ADDING DETERGENT - FIG. 2

Attach the cable tidy (12). Locate and slide into place. Remove the detergent filler cap (28) and fill with suitable detergent.

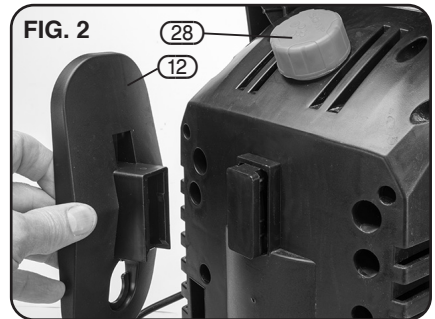

## 8. SETTING THE PRESSURE WASHER

### 8.3 ASSEMBLING THE LANCE AND HOSE - FIGS. 3 - 5

Connect the lance (19) to the trigger assembly (17) by pushing in the bayonet fitting and turning anti-clockwise 45° to lock in place.

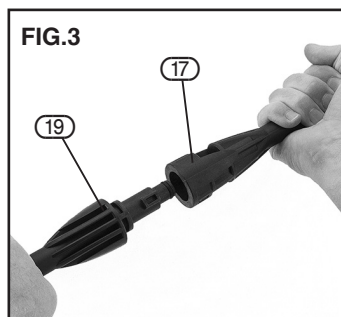

To connect the high pressure hose (3) to the trigger assembly (17), push-fit the hose connector into the inlet on the assembly. Disconnection of the hose is achieved by pressing the hose release button (16).

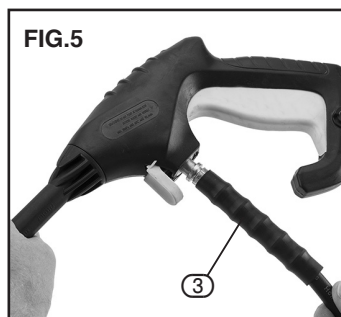
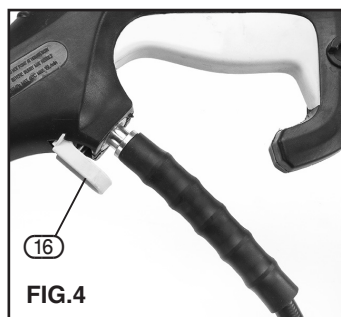

## 8. SETTING THE PRESSURE WASHER

---

### 8.4 ATTACHING THE WATER SUPPLY - FIGS. 6-7

To attach the pressure washer to the water supply a push fit hose connector will be required. Ensure the connector is correctly fitted to the hose and that a 'click' is heard when attaching to the machine. The inlet is located on the front of the machine.

The supply must be between 1.5Bar and 6.0Bar and 7 litres/min.

**NOTE:** Always observe local byelaws and regulations.

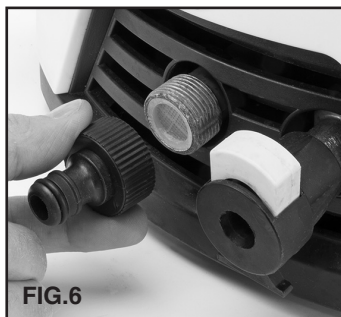

# 9. OPERATING THE PRESSURE WASHER

## NOTE:

Remove the plug from the socket before carrying out adjustment, servicing or maintenance.

### 9.1 ON/OFF SWITCH - FIG. 8

NOTE: Do not run the motor “DRY”, and ensure the machine is switched “OFF” prior to plugging in.

This pressure washer is designed to be used in the upright position only.

To operate the pressure washer correctly carry out the following steps:

- Turn switch off.
- Plug in the pressure washer.
- Connect and turn on the water supply.
- Pull the trigger to bleed the air out of the system.
- Whilst the trigger is pulled switch on the pressure washer.
- When the air is purged release the trigger.

The machine is now ready for use. Ensure that during use the jet is not aimed at people, animals, electrical equipment or the pressure washer.

To achieve the desired spray pattern from the adjustable jet nozzle (23), turn the nozzle at the end of gun assembly (Fig.9).

After use:

- Switch off and unplug the pressure washer.
- Switch off the water supply.
- Pull the trigger to release the pressure and drain the water.
- Disconnect the hose connection.
- Disassemble the lance, trigger and hose from the machine.
- Drain all remaining water and store away safely.

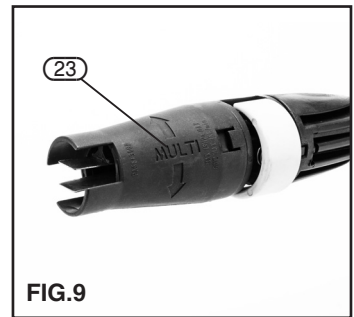



# 10. ACCESSORIES

## 10.1 90° NOZZLE - FIG. 10

The 90° nozzle (24) is for effective cleaning of difficult to reach areas eg. roof gutters or vehicle underbodies. Be careful that high pressure water can remove paint and other surface treatments. It can also damage tarmac and may remove grouting between paving slabs.

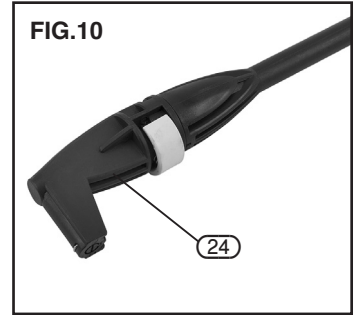

## 10.2 FIXED BRUSH - FIGS. 11 - 12.

The fixed brush (26) supplied can be used to remove stubborn dirt on a variety of surfaces.

Be aware that foreign matter can get stuck within the bristles of the brush and can scratch the surface being cleaned.



## 10.3 TURBO NOZZLE - FIG. 13.

The turbo nozzle (25) is ideal for removing ground in dirt and grime.

The spinning water jet hits the surface dirt from multiple angles. As a result turbo nozzles can cut cleaning time in half.

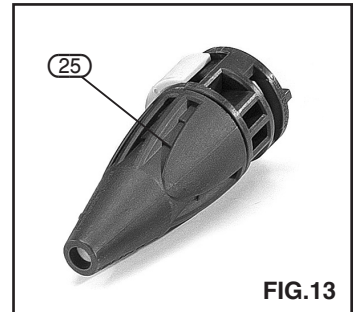

FIG.13

# 10. ACCESSORIES

## 10.4 ASSEMBLING AND ATTACHING THE PATIO CLEANER - FIGS. 14 - 15

The patio cleaning brush has a rotating arm with two nozzles to allow quick and effective cleaning of large flat areas.

Attach the patio cleaning lance (21) to the brush (11) by pushing the lance into position.

Position the patio cleaning spray (20) and secure using the split pin and screws (27) supplied (Fig.12).

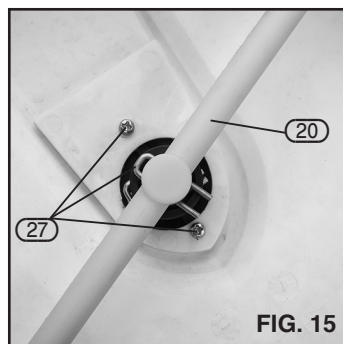
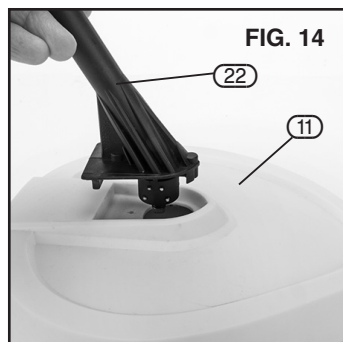

# 11. TROUBLESHOOTING

## 11.1 TROUBLESHOOTING

Trouble	Possible Cause	Remedy
Motor pulsing.	Air in the system.	See the section on bleeding (see page 16).
Pump fails to start.	Plug fuse blown. Cable damaged.	Replace fuse. Have the cable replaced by a repair agent.
Pump starts/stops with the trigger operation.	Correct operation of the total stop device.	Nothing.
Bad spray pattern.	Nozzle blocked.	Unblock nozzle (see fig. 16 below).
Poor pressure.	Water leaks.	Check and tighten all the connections.

## 11.2 CLEANING PIN - FIG. 16

Use the cleaning pin (22) to remove foreign matter from the nozzle.

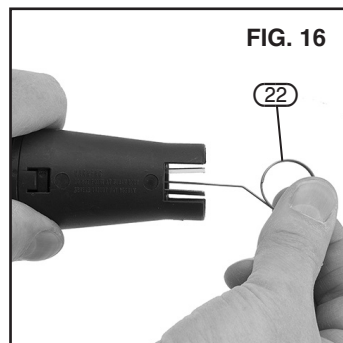

## 12. EXPLANATION OF SYMBOLS

---

### 12.1 EXPLANATION OF SYMBOLS/PICTOGRAMS

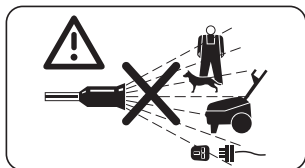

Do not point hose at people, animals, pressure washer or electrical points.



Do not dispose of WEEE\* as unsorted municipal waste.



Class II construction  
(Double insulated).



Single value noise marking.  
(Maximum declared A-Weighted sound power level in decibels).

# 13. DISPOSAL

---

## 13.1 DISPOSAL

- At the end of the machine's working life, or when it can no longer be repaired, ensure that it is disposed of according to national regulations.
- Contact your local authority for details of collection schemes in your area.

In all circumstances:

- Do not dispose of power tools with domestic waste.
- Do not incinerate.
- Do not abandon in the environment.
- Do not dispose of WEEE\* as unsorted municipal waste.



\* Waste Electrical & Electronic Equipment.

# NOTES

---



## CONTACT US

Draper Tools Limited, Hursley Road,  
Chandler's Ford, Eastleigh, Hampshire. SO53 1YF. U.K.

Helpline: +44 (0) 23 8049 4344

Sales Desk: +44 (0) 23 8049 4333

Internet: [www.drapertools.com](http://www.drapertools.com)

E-mail: [sales@drapertools.com](mailto:sales@drapertools.com)

General Enquiries: (023) 8026 6355

**Service/Warranty Repair Agent:**

For aftersales servicing or warranty repairs, please contact the  
Draper Tools Helpline for details of an agent in your local area.

YOUR DRAPER STOCKIST

©Published by Draper Tools Limited.

No part of this publication may be reproduced, stored in a retrieval system or transmitted in any form or by any means, electronic, mechanical photocopying, recording or otherwise without prior permission in writing from Draper Tools Ltd.