

**DRAPER**<sup>®</sup>

**STORMFORCE**

INSTRUCTIONS FOR  
**850W 230V**  
**SDS+ Hammer Drill Kit**

Stock No.83588 Part No.PT850SF

**IMPORTANT:** PLEASE READ THESE INSTRUCTIONS CAREFULLY TO ENSURE THE SAFE AND EFFECTIVE USE OF THIS PRODUCT.



CE

**DRAPER**<sup>®</sup>

## GENERAL INFORMATION

These instructions accompanying the product are the original instructions. This document is part of the product, keep it for the life of the product passing it on to any subsequent holder of the product. Read all these instructions before assembling, operating or maintaining this product.

This manual has been compiled by Draper Tools describing the purpose for which the product has been designed, and contains all the necessary information to ensure its correct and safe use. By following all the general safety instructions contained in this manual, it will ensure both product and operator safety, together with longer life of the product itself.

All photographs and drawings in this manual are supplied by Draper Tools to help illustrate the operation of the product. Whilst every effort has been made to ensure the accuracy of information contained in this manual, the Draper Tools policy of continuous improvement determines the right to make modifications without prior warning.

# 1. TITLE PAGE

---

## 1.1 INTRODUCTION:

USER MANUAL FOR:

### 850W 230V SDS+ HAMMER DRILL

Stock no. 83588

Part no. PT850SF

## 1.2 REVISIONS:

Date first published April 2016

\_\_\_\_\_

\_\_\_\_\_

\_\_\_\_\_

As our user manuals are continually updated, users should make sure that they use the very latest version.

Downloads are available from: <http://www.drapertools.com/manuals>

DRAPER TOOLS LIMITED

HURSLEY ROAD

CHANDLER'S FORD

EASTLEIGH

HAMPSHIRE

SO53 1YF

UK

WEBSITE: [drapertools.com](http://drapertools.com)

PRODUCT HELP LINE: +44 (0) 23 8049 4344

GENERAL FAX: +44 (0) 23 8026 0784

## 1.3 UNDERSTANDING THIS MANUALS SAFETY CONTENT:

**WARNING!** Information that draws attention to the risk of injury or death.

**CAUTION!** Information that draws attention to the risk of damage to the product or surroundings.

## 1.4 COPYRIGHT © NOTICE:

Copyright © Draper Tools Limited.

Permission is granted to reproduce this publication for personal & educational use only.

Commercial copying, redistribution, hiring or lending is prohibited.

No part of this publication may be stored in a retrieval system or transmitted in any other form or means without written permission from Draper Tools Limited.

In all cases this copyright notice must remain intact.

---

# 2. CONTENTS

---

## 2.1 CONTENTS

	<b>PAGE CONTENT</b>	<b>PAGE</b>
1	TITLE PAGE	
	1.1 INTRODUCTION .....	2
	1.2 REVISION HISTORY .....	2
	1.3 UNDERSTANDING THIS MANUAL .....	2
	1.4 COPYRIGHT NOTICE .....	2
2	CONTENTS	
	2.1 CONTENTS .....	3
3	GUARANTEE	
	3.1 GUARANTEE .....	4
4	INTRODUCTION	
	4.1 SCOPE .....	5
	4.2 SPECIFICATION .....	5
	4.3 HANDLING & STORAGE .....	5
5	HEALTH & SAFETY INFORMATION	
	5.1 GENERAL SAFETY INSTRUCTIONS .....	6 - 7
	5.2 ADDITIONAL SAFETY INSTRUCTIONS .....	7
	5.3 CONNECTION TO THE POWER SUPPLY .....	7
6	TECHNICAL DESCRIPTION	
	6.1 IDENTIFICATION .....	8
7	UNPACKING & CHECKING	
	7.1 PACKAGING .....	9
	7.2 WHAT'S IN THE BOX? .....	9
8	PREPARING THE DRILL	
	8.1 AUXILIARY HANDLE AND DEPTH STOP .....	10
9	BASIC HAMMER DRILL OPERATIONS	
	9.1 FUNCTION SELECTOR .....	11
	9.2 SWITCH OPERATION .....	12
	9.3 DRILL/CHISELLING MASONRY .....	12
	9.4 DRILLING WOOD AND PLASTIC .....	12
	9.5 DRILLING METAL .....	12
	9.6 SDS+ SYSTEM .....	12
10	MAINTENANCE	
	10.1 MAINTENANCE .....	13
11	TROUBLESHOOTING .....	13
12	OPTIONAL ACCESSORIES .....	13
13	EXPLANATION OF SYMBOLS	
	13.1 EXPLANATION OF SYMBOLS .....	14
14	DISPOSAL	
	14.1 DISPOSAL .....	15
	DECLARATION OF CONFORMITY .....	ENCLOSED

## 3. GUARANTEE

---

### 3.1 *GUARANTEE*

Draper tools have been carefully tested and inspected before shipment and are guaranteed to be free from defective materials and workmanship.

Should the tool develop a fault, please return the complete tool to your nearest distributor or contact Draper Tools Limited, Chandler's Ford, Eastleigh, Hampshire, SO53 1YF. England.

Telephone Sales Desk: (023) 8049 4333 or Product Help Line (023) 8049 4344.

A proof of purchase must be provided with the tool.

If upon inspection it is found that the fault occurring is due to defective materials or workmanship, repairs will be carried out free of charge. This guarantee period covering parts/labour is 12 months from the date of purchase except where tools are hired out when the guarantee period is 90 days from the date of purchase. The guarantee is extended to 24 months for parts only. This guarantee does not apply to normal wear and tear, nor does it cover any damage caused by misuse, careless or unsafe handling, alterations, accidents, or repairs attempted or made by any personnel other than the authorised Draper warranty repair agent.

Note: If the tool is found not to be within the terms of warranty, repairs and carriage charges will be quoted and made accordingly.

This guarantee applies in lieu of any other guarantee expressed or implied and variations of its terms are not authorised.

Your Draper guarantee is not effective unless you can produce upon request a dated receipt or invoice to verify your proof of purchase within the guarantee period.

Please note that this guarantee is an additional benefit and does not affect your statutory rights.

Draper Tools Limited.

## 4. INTRODUCTION

---

### 4.1 SCOPE

This powerful SDS hammer drill is ideal for most construction jobs. Primarily suited to masonry drilling this machine can also be used for light duty chiselling applications. It is intended for domestic and light commercial use. Any other application is considered misuse.

### 4.2 SPECIFICATION

Stock no. ....	83588
Part no. ....	PT8505F
Rated voltage .....	230V~50Hz
Rated input .....	850W
Drilling capacity:	
Wood .....	30mm
Mild steel .....	13mm
Masonry .....	26mm
Impact force .....	3 Joules
Revolutions per minute (no load) .....	0-1100min <sup>-1</sup>
Impact rate .....	0-4900min <sup>-1</sup>
Chuck type .....	SDS Plus
Sound pressure level .....	91.8dB(A)
Sound power level .....	102.8dB(A)
Vibration level:	
main handle .....	15.81m/s <sup>2</sup>
side handle .....	14.09m/s <sup>2</sup>
Weight (drill only) .....	3.374kg
Weight (including accessories and carry case) .....	5.308kg

### 4.3 HANDLING & STORAGE

The environment will have a negative result on its operation if you are not careful. If the air is damp, components will rust. If the machine is unprotected from dust and debris; components will become clogged: And if not cleaned and maintained correctly or regularly the machine will not perform at its best.

# 5. HEALTH & SAFETY INFORMATION

---

## 5.1 GENERAL SAFETY INSTRUCTIONS

### General Power Tools Safety Warnings

**WARNING:** Read all instructions. Failure to follow all instructions listed below may result in electric shock, fire and/or serious injury.

Save all warnings and instructions for future reference.

The term “power tool” in the warnings refers to your mains operated (corded) power tool or battery operated (cordless) power tool.

#### 1) Work area safety

- a) **Keep work area clean and well lit.** Cluttered or dark areas invite accidents.
- b) **Do not operate power tools in explosive atmospheres, such as in the presence of flammable liquids, gases or dust.** Power tools create sparks which may ignite the dust or fumes.
- c) **Keep children and bystanders away while operating a power tool.** Distractions can cause you to lose control.

#### 2) Electrical Safety

- a) **Power tool plugs must match the outlet.** Never modify the plug in any way. Do not use any adapter plugs with earthed (grounded) power tools. Unmodified plugs and matching outlets will reduce risk of electrical shock.
- b) **Avoid body contact with earthed or grounded surfaces such as pipes, radiators, ranges and refrigerators.** There is an increased risk of electric shock if your body is earthed or grounded.
- c) **Do not expose power tools to rain or wet conditions.** Water entering a power tool will increase the risk of electric shock.
- d) **Do not abuse the cord. Never use the cord for carrying, pulling or unplugging the power tool.** Keep cord away from heat, oil, sharp edges or moving parts. Damaged or entangled cords increase the risk of electric shock.
- e) **When operating a power tool outdoors, use an extension cord suitable for outdoor use.** Use of a cord suitable for outdoor use reduces the risk of electric shock.
- f) **If operating a power tool in a damp location is unavoidable, use a residual current device (RCD) protected supply.** Use of an RCD reduces the risk of electric shock.

#### 3) Personal Safety

- a) **Stay alert, watch what you are doing and use common sense when operating a power tool. Do not use a power tool while you are tired or under the influence of drugs, alcohol or medication.** A moment of inattention while operating power tools may result in serious personal injury.
- b) **Use personal protective equipment. Always wear eye protection.** Protective equipment such as dust mask, nonskid safety shoes, hard hat, or hearing protection used for appropriate conditions will reduce personal injuries.
- c) **Prevent unintentional starting. Ensure the switch is in the off position before connecting to power source and/or battery pack, picking up or carrying the tool.** Carrying power tools with your finger on the switch or energising power tools that have the switch on invites accidents.
- d) **Remove any adjusting key or wrench before turning the power tool on.** A wrench or a key left attached to a rotating part of the power tool may result in personal injury.
- e) **Do not overreach. Keep proper footing and balance at all times.** This enables better control of the power tool in unexpected situations.
- f) **Dress properly. Do not wear loose clothing or jewellery. Keep your hair, clothing and gloves away from moving parts.** Loose clothes, jewellery or long hair can be caught in moving parts.

## 5. HEALTH & SAFETY INFORMATION

---

g) If devices are provided for the connection of dust extraction and collection facilities, ensure these are connected and properly used. Use of dust collection can reduce dust related hazards.

### 4) Power Tool Use And Care

- a) **Do not force the power tool. Use the correct power tool for your application.** The correct power tool will do the job better and safer at the rate for which it was designed.
- b) **Do not use the power tool if the switch does not turn it on and off.** Any power tool that cannot be controlled with the switch is dangerous and must be repaired.
- c) **Disconnect the plug from the power source and/or the battery pack from the power tool before making any adjustments, changing accessories, or storing power tools.** Such preventative safety measures reduce the risk of starting the power tool accidentally.
- d) **Store idle power tools out of the reach of children and do not allow persons unfamiliar with the power tool or these instructions to operate the power tool.** Power tools are dangerous in the hands of untrained users.
- e) **Maintain power tools. Check for misalignment or binding of moving parts, breakage of parts and any other condition that may affect the power tools operation. If damaged, have the power tool repaired before use.** Many accidents are caused by poorly maintained power tools.
- f) **Keep cutting tools sharp and clean.** Properly maintained cutting tools with sharp cutting edges are less likely to bind and are easier to control.
- g) **Use the power tool, accessories and tool bits etc., in accordance with these instructions, taking into account the working conditions and the work to be performed.** Use of the power tool for operations different from intended could result in a hazardous situation.

### 5) Service

- a. **Have your power tool serviced by a qualified repair person using only identical replacement parts.** This will ensure that the safety of the power tool is maintained.

## 5.2 ADDITIONAL SAFETY INSTRUCTIONS

- Wear ear protectors with impact drills. Exposure to noise can cause hearing loss.
- Use auxiliary handles supplied with the tool. Loss of control can cause personal injury.
- Wear eye protection.
- Wear dust mask.

## 5.3 CONNECTION TO THE POWER SUPPLY

Make sure the power supply information on the machine's rating plate are compatible with the power supply you intend to connect it to.

This product comes supplied with a UK standard 3 pin plug fitted. It is designed for connection to a domestic power supply rated at 230V AC.

This appliance is Class II† and is designed for connection to a power supply matching that detailed on the rating label and compatible with the plug fitted.

If an extension lead is required, use an approved and compatible lead rated for this appliance. Follow all the instruction supplied with the extension lead.

†Double insulated : This product requires no earth connection as supplementary insulation is applied to the basic insulation to protect against electric shock in the event of failure of the basic insulation.

Apart from replacing the fuse in the plug, no other electrical work is recommended on this drill.

## 6. TECHNICAL DESCRIPTION

---

### 6.1 IDENTIFICATION



- ① SDS+ chuck
- ② Mode selection switch
- ③ Variable speed dial
- ④ Trigger switch

- ⑤ Forward/reverse selector
- ⑥ Trigger lock
- ⑦ Plug and cable



# 7. UNPACKING & CHECKING

## 7.1 PACKAGING

Carefully remove the drill from the packaging and examine it for any sign of damage that may have happened during shipping. Lay the contents out and check them against the parts shown below. If any part is damaged or missing; please contact the Draper Help Line (the telephone number appears on the Title page) and do not attempt to use the product. The packaging material should be retained at least during the guarantee period: in case the machine needs to be returned for repair.

Warning! Some of the packaging materials used may be harmful to children. Do not leave any of these materials in the reach of children.

If any of the packaging is to be thrown away, make sure they are disposed of correctly; according to local regulations.

## 7.2 WHAT'S IN THE BOX?

As well as the drill; there are several parts not fitted or attached to it.

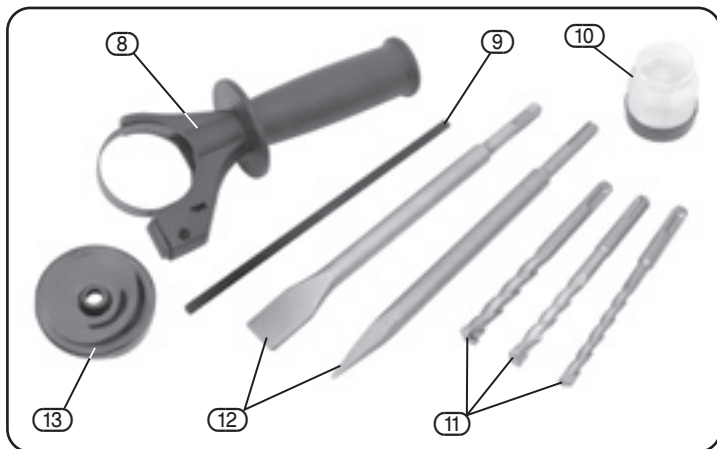

- ⑧ Auxiliary handle
- ⑨ Depth guide
- ⑩ Grease pot
- ⑪ 150mm SDS+ 3x masonry drill bits (8, 10, 12mm)
- ⑫ 250mm SDS+ chisels x2 (flat & point)
- ⑬ Dust cover

## 8. PREPARING THE DRILL

NOTE: Remove the plug from the socket before carrying out adjustment, servicing or maintenance.

### 8.1 AUXILIARY HANDLE AND DEPTH STOP - FIG. 1

WARNING: Use auxiliary handle supplied with the tool. Loss of control can cause personal injury.

- i. To fit the auxiliary handle (8), ensure the hand grip is loose (screw anti-clockwise to loosen).
- ii. Sliding it over the drill's chuck onto the collar.
- iii. Select the required angle of the handle and tighten the handgrip to secure.
- iv. To fit the depth stop (9) into the auxiliary handgrip (8), loosen the grip (screw anti-clockwise to loosen).
- v. Insert the depth stop (9) into the adjustable handle and position for the correct depth, then tighten grip (screw clockwise to tighten).

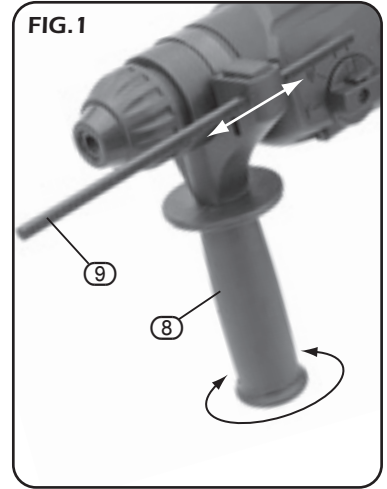

## 9. BASIC HAMMER DRILL OPERATIONS

**WARNING:** Prior to beginning any drilling, carefully check the surface for the presence of electric cable, gas or water pipes and other dangerous or damaging contents. If unsure do not proceed.

**NOTE:** Remove the plug from the socket before carrying out adjustment, servicing or maintenance.

### 9.1 FUNCTION SELECTOR - FIGS. 2 - 4

#### ROTARY DRILLING

- i. With the drill at standstill press the lock button (2.1).
- ii. Rotate the function selector lever (2) to the backward position (⚙️).  
This set-up is for standard drilling ie. into wood.

#### HAMMER DRILLING

- i. With the drill at standstill press the lock button (2.1).
- ii. Rotate the function selector lever (2) to the upright position (⚡️).  
This set-up is for masonry drilling ie. into brick, concrete, block work, etc.

#### PNEUMATIC CHISELLING

- i. With the drill at standstill press the lock button (2.1).
- ii. Rotate the function selector lever (2) to the forward/upper position (⚡️).  
This set-up is for chiselling with the chuck rotation stop engaged, ie. chiselling/chasing out brickwork, plaster etc.

#### CHISELLING

- i. With the drill at standstill press the lock button (2.1).
- ii. Rotate the function selector lever (2) to the forward position (⚡️).  
This set-up is for chiselling ie. chiselling/chasing out brickwork, plasterboard, etc.

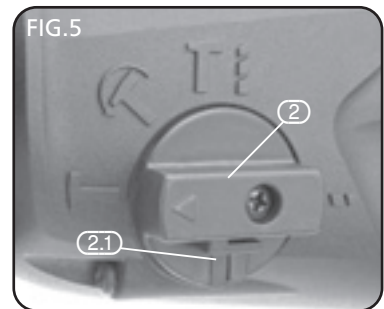
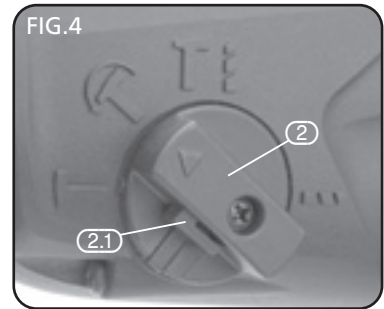
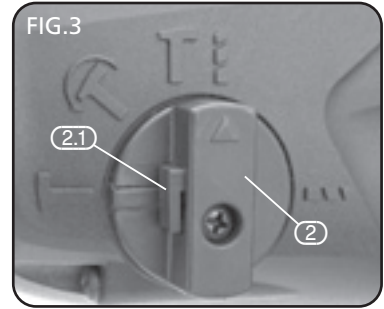
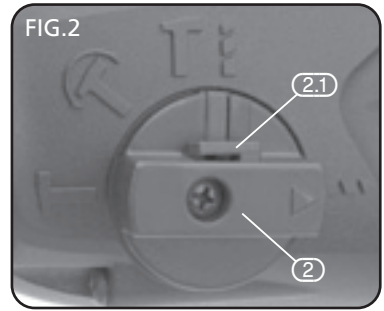

## 9. BASIC HAMMER DRILL OPERATIONS

**IMPORTANT:** Make sure that the mains voltage matches the voltage stated on the machines rating plate.

### 9.2 SWITCH OPERATION - FIG 6

The switch (4) on this tool is fitted with a locking device, (6), allowing the tool to be operated for long periods of time without interruptions.

Before inserting the plug into the socket, check that the switch is in the unlocked position. When the tool is not to be used for long periods, remember to leave the switch device in the unlocked position.

### CHANGING THE DIRECTION OF ROTATION

These models are equipped with a reverse selector (5) in order to be able to rotate the machine chuck either clockwise or anti clockwise.

This operation should be performed when the machine is stopped.

Because of this feature, the drill can also be used as a screwdriver.

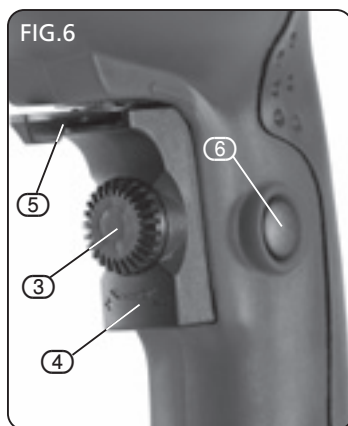

### 9.3 DRILL/CHISELLING MASONRY

Tiles, bricks, blocks and other masonry can be drilled and if applicable chiselled.

### 9.4 DRILLING WOOD AND PLASTIC

To prevent wood splitting around the drill holes on the reverse side, place a piece of scrap timber under the material to be drilled.

### 9.5 DRILLING METAL

Metals such as sheet steel, aluminium and brass may be drilled. Mark the point to be drilled with a centre punch to help the drill bit tip to locate.

### 9.6 SDS+ SYSTEM - FIG. 7

The tool holder (1.2) clamps SDS+ drill bits and chisels without the need for a chuck key. Pull collar (1.3) back. Insert the bit. It may be necessary to rotate the bit to ensure it engages correctly. Release the collar to lock the bit in place. Check by pulling the bit to see if it's firmly seated.

**IMPORTANT:** Always clean and lightly grease the tool shaft before inserting into the chuck.

Take care that the dust protection cap is not damaged. Allowing dust and debris inside the holder will cause problems in the future.

To remove a bit, slide the collar (1.3) to the rear and pull out the tool.

**WARNING:** Bit will be hot after use.

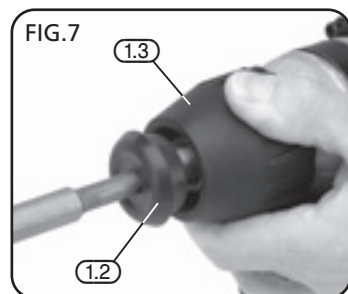

## 10. MAINTENANCE

---

### 10.1 MAINTENANCE

NOTE: Remove the plug from the socket before carrying out adjustment, servicing or maintenance.

The Hammer Drill does not require any special maintenance. Regularly clean/vacuum the ventilation slots. Use only a mild cleaner and a damp cloth to clean the tool.

## 11. TROUBLESHOOTING

---

NOTE: Remove the plug from the socket before carrying out adjustment, servicing or maintenance.

PROBLEM	POSSIBLE CAUSE	REMEDY
Motor does not start.	1. Fuse.	1. Replace/reset 5 amp time delay fuse or circuit breaker.
	2. Brushes worn.	2. Have carbon brushes replaced in motor.
	3. Unsure.	3. Return to an authorised service agent for diagnosis.

## 12. OPTIONAL ACCESSORIES

---

For a full range of optional accessories, please refer to your local Draper Stockist.

# 13. EXPLANATION OF SYMBOLS

---

## 13.1 EXPLANATION OF SYMBOLS



Warning!  
Wear dust mask.



Warning!  
Read the instruction manual



Warning!  
Wear suitable eye/face  
protection.



Warning!  
Wear ear defenders.



WEEE  
Do not dispose of Waste Electrical  
& Electronic Equipment in with  
domestic rubbish



Class II construction  
(Double insulated).

# 14. DISPOSAL

---

## 14.1 DISPOSAL

- At the end of the machine's working life, or when it can no longer be repaired, ensure that it is disposed of according to national regulations.
- Contact your local authority for details of collection schemes in your area.

In all circumstances:

- Do not dispose of power tools with domestic waste.
- Do not incinerate.
- Do not abandon in the environment.
- Do not dispose of WEEE\* as unsorted municipal waste.



\* Waste Electrical & Electronic Equipment.

- **DRAPER TOOLS LIMITED,**  
Hursley Road, Chandler's Ford,  
Eastleigh, Hampshire. SO53 1YF. U.K.
- **Help Line:** (023) 8049 4344
- **Sales Desk:** (023) 8049 4333
- **General Enquiries:** (023) 8026 6355
- **Service/Warranty Repair Agent**  
For aftersales servicing or warranty repairs, please  
contact the Draper Tools Help Line for details of an  
agent in your local area.

YOUR DRAPER STOCKIST

RDCH0816

