

KEY No.	PART No.	STOCK No.	DESCRIPTION
1	C248051150B	55097	150L Reservoir tank
2	C011019000	73494	Plug
3	C022020000	28395	Drain cock
4	C322002000	28474	Line cock
5	C199647000	31119	Fitting
6	C047210000	73495	Safety valve
7	C330007000	73496	Pressure gauge
8	C130505040	31107	Plug & cable
9	C131501046	73497	Pressure switch
10	C014005007	28535	Square washer
11	C010025000	73498	Belt guard fixing
12	C199688000	73499	Belt guard
13	C130806021	28408	Non-return valve
14	C046001000	34728	Return tube
15	C117000185	31122	Delivery tube
16	C045029000	51367	Belt
17	C5131690000	73500	Pump unit
18	C113150002	73471	Cowling
19	C540E016605	73501	Motor assembly
20	C130308040	73502	Pulley

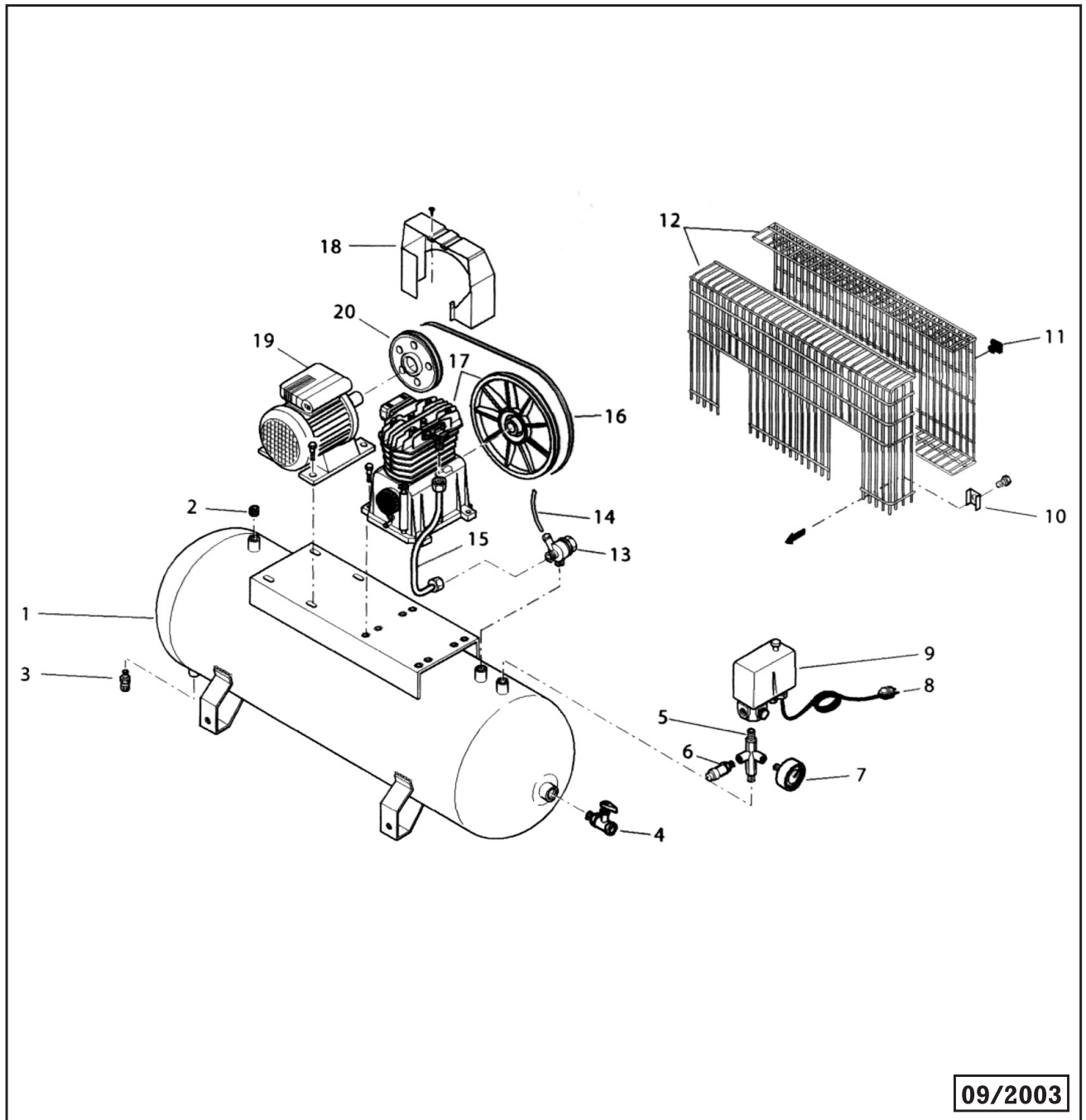

SPECIFICATION:

STOCK No.69337	PART No.DA150/392B
Air displacement:	390L/min (13.8cfm)
Free air delivered (FAD):	262L/min (9.3cfm)
Motor:	3HP-230V
Speed:	1420rpm
Maximum pressure:	145PSI (10.0 bar)
Number of cylinders:	2
Receiver capacity:	150 litres

KEY No.	PART No.	STOCK No.	DESCRIPTION
1	C014013054	73474	Bolt M5x12
2	C113149015	28541	Lower cover
3	C113167001	73475	Casing
4	C033027000	73476	Bearing 6205
5	C010053000	28543	Seal
6	C113149008	28546	Front cover
7	C014013021	28518	Bolt M6x20
8	C013160010	38757	Flywheel
9	C014005001	28572	Washer
10	C113160011	73477	Bolt M8
11	C014013082	28548	Bolt M8x20
12	C014005025	28547	Washer
13	C113149009	73478	Rear cover
14	C012036000	73479	Oil dipstick
15	C014010044	73480	Bolt M8x20
16	C113167003	73481	Crankshaft
17	C113150004	28555	Con rod
18	C216025002	28559	Piston ring kit
19	C113165013	28558	Piston Ø60
20	C116025006	28557	Gudgeon pin
21	C015099000	73503	Circlip
22	C416025017	28560	Complete piston
23	C113169003	73504	Cylinder
24	C413149080	28565	Valve plate
25	C113149050	73489	Head
26	C017024000	73491	Air filter
27	C317026000	73492	Intake filter assembly
28	C014002041	73490	Bolt M8x50
29	C013169004	73505	Manifold
30	C014006121	28393	Bolt
32	C213169001	73506	Complete gasket kit

